

- ✓ RIGHT PRODUCTS
- ✓ RIGHT PLACE
- ✓ RIGHT TIME

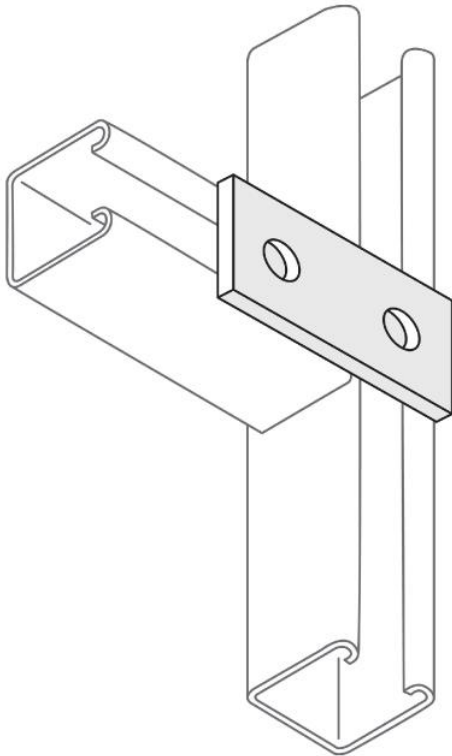

## Splice Plate, 2-Hole

Splice Plate, 2-hole with Hot Dipped Galvanised (HDG) finish.

Splice Plates are used on the installation of channel support systems, to join several channel sections together.

---

Technical data supplied by the manufacturer.

### Description

---

Dimensions: 40 x 80mm

Sizes: Clearance Hole 14mm and Bracket is 5mm Thick

Material: Mild Steel

Finish: Hot Dipped Galvanised (HDG)

Country of Origin: India

**Remark:** This technical data sheet replaces all previous versions. The technical data contained herein is given in good faith and we cannot be held liable for any errors, inaccuracies, omissions or editorial failings. The information detailed in this technical data sheet is given by way of indication and is not exhaustive, users should contact either the seller or the manufacturer of the product for additional technical information concerning its use, if they think the information in their possession needs to be clarified in any way. Any illustrations shown are indicative only, and dimensions may differ slightly from batch to batch.